

IR Quattro HD DIM-24

Presence Detector



The IR Quattro HD DIM-24 is a low voltage, high definition, passive infrared presence detector that is setting a new standard in lighting control. Featuring 1-10 volt dimming coupled with four pyroelectric detectors and a high performance lense system that creates 4,800 presence detection switching zones. Provides superior presence detection, energy savings and occupant convenience. Lighting is controlled in relation to the presence of motion, the user selected dim level by remote or momentary switch and ambient light levels. As soon as occupancy is detected, the sensor goes to either the last selected electric light dim level (constant-lighting controller 'OFF') or adjusts to the last selected electric light + daylight brightness level (constant-lighting controller 'ON'). The "force off" light level feature will turn lights off when sufficient daylight is present for additional energy savings. When no movement is detected and the occupancy time setting has elapsed, the sensor dims light levels back to basic brightness, after the Stay 'ON' time DIM before 'OFF' delay has expired the light turns off. The innovative mechanical reach setting enables the designer with a precise method of controlling lighting zones by means of optimizing the sensors detection reach without compromising sensitivity providing true precise presence detection in the desired detection zone. Operational choices of auto on or manual on with a momentary or maintained switch input. The convenient "COM-Link" feature enables multiple sensors to link together via the communication link for peer to peer grouping achieving expanded detection zones with control set up functions set at only one primary sensor for the entire group. The available service and user wireless remotes provide simplified commissioning and occupant convenience.

The Control PRO group of presence detectors are available in multiple presence detection technologies for the control of heating, ventilation and air-conditioning (HVAC) and lighting loads (as in the COM2-24 versions) and optional 1-10 volt dimming and daylighting options (in the DIM-24 versions).

Applications

The typical application is for offices, schools and other indoor public building spaces.

Project Name:

Location:



IR Quattro HD DIM-24 Specifications

Item No.	64480 IR Quattro HD DIM-24
Accessories	65300 RC 3 service remote 65320 RC 4 user remote 65330 WGC wire guard cage
Voltage	18-24 VDC/VAC 46mA
Load Rating	control output (blue) 1 A @ 30 VAC/VDC 1 - 10 volt dimming output (purple & gray) 100 mA, max. 50 (1 - 10 V electronic dimming ballasts)
Sensing Technology	passive infrared (PIR)
Time Delay Setting	30 sec. to 30 min., pulse mode (approx. 2 sec.), IQ mode (automatic adjustment to the usage profile)
Light Level Setting	10 - 1000 lux / 1 - 100 fc
Environment	IP20 rated, 0°C to +40°C, 32°F to +104°F
Installation Height	2.5 - 10 m / 8 - 32 ft
Coverage at 9 ft	360° square mechanically scalable detection zones presence: max. 7.9 x 7.9 m (62.41 sq.m.) max. 25.5 x 25.5 ft (650.25 sq.ft.) radially: max. 7.9 x 7.9 m (62.41 sq.m.) max. 25.5 x 25.5 ft (650.25 sq.ft.) tangentially: max. 20 x 20 m (400.0 sq.m.) max. 65.5 x 65.5 ft (4,290.25 sq.ft.)
Lens Design	13 detection levels, 4800 switching zones
Dimensions	4.72 x 4.72 x 2.83 in, 120 x 120 x 72 mm (LxWxD)
Warranty	5 years
Certifications	C-UL-US Listed, RoHS compliant UL 2043 Plenum rated, CA Energy Code compliant

Key Features:

- Low voltage (18-24 VDC/VAC) sensor for use with a power pack or building automation system
- 1-10 volt dimming
- Stay 'ON' time DIM before 'OFF'
- Constant light level DIM control option
- 4 pyros (Infrared Pyroelectric Detectors)
- Mechanical reach setting
- Square coverage pattern with 4800 switching zones
- Service and user wireless remotes available
- Manual ON mode (MAN) / Automatic mode (AUTO)
- Momentary / Maintained switch option
- 'ON' only / 'ON' & 'OFF' manual switching
- "COM-Link" communication allows for up to 10 sensors to be grouped together

HD

4800 PIR Detection Zones



26 x 26 Ft Presence
65 x 65 Ft Tangential



1 - 100 fc

DIM

18 - 24 VDC/VAC
1 - 10 Volt Dimming



30 sec - 30 min

IR Quattro HD DIM-24

Presence Detector



Wiring

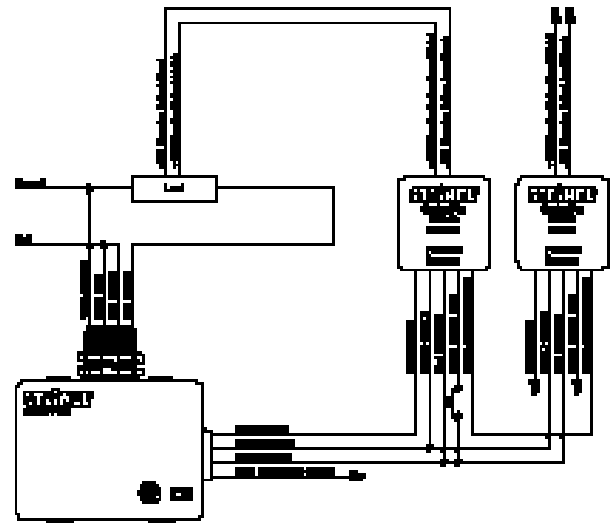
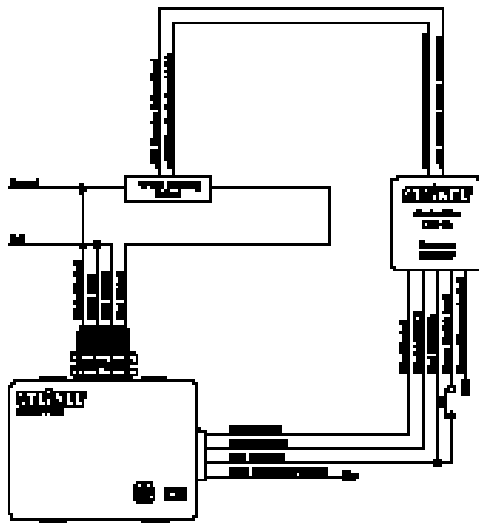

Setting

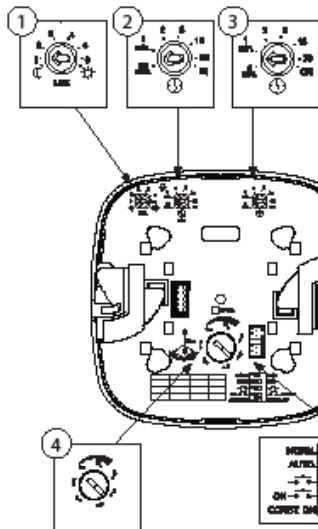

- 1 - Light level setting
- 2 - Occupancy time delay setting
- 3 - Stay 'ON' time DIM before 'OFF'
- 4 - Reach setting
- 5 - Sensor DIP switch settings

Mechanical Scalability

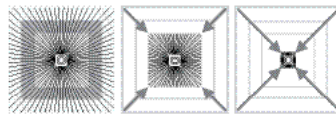

Coverage

Shown at 9 ft mounting height. Coverage will vary depending on mounting height. See pages 4 & 5 of the instruction manual for coverage at heights from 8 to 26 ft. Maximum mounting height up to 32 ft.

One Gridline = 1 m / 3 ft

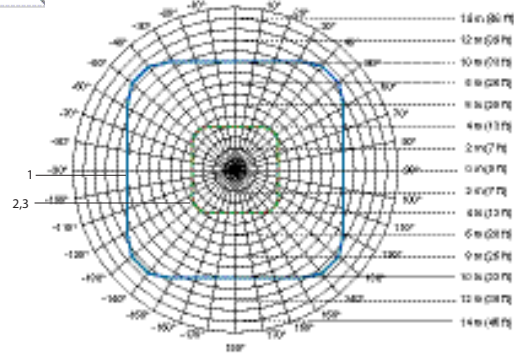

- 1 - Tangential - motion perpendicular to the sensor (65.6 x 65.6 ft)
- 2 - Radial - motion either toward or away from the sensor (26.25 x 26.25 ft)
- 3 - Radial - minor motion as described by NEMA with the additional benefit of both radial and tangential detection (26.25 x 26.25 ft)

- DIP 1 - Normal mode / Test mode (NORM / TEST)
- DIP 2 - Manual ON mode (MAN) / Automatic mode (AUTO)
- DIP 3 - Momentary / Maintained switch option
- DIP 4 - 'ON' only / 'ON' & 'OFF' manual switching
- DIP 5 - Constant light level DIM control option

Mounting

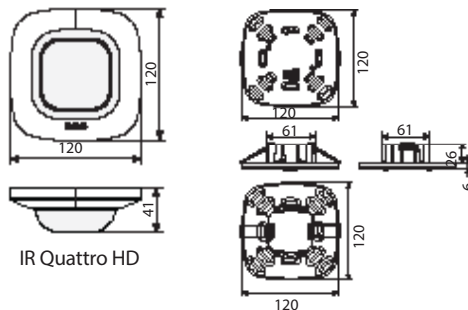
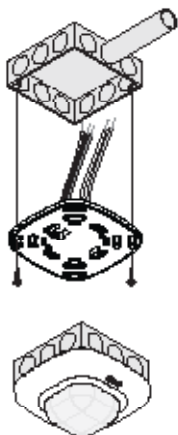

IR Quattro HD

Mounts to a 4" Square box, 4" Octagon box or Round 3.0 Mud-Ring

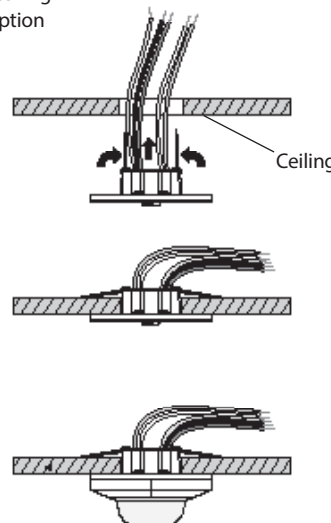

Mounts directly to ceiling with quick mount spring tabs

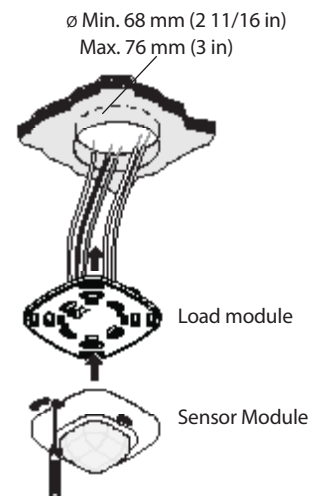

Load module

Sensor Module